

Since 1906

America's finest custom windows

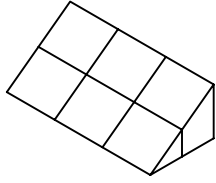

LEAN-TO

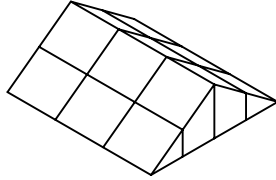

RIDGE

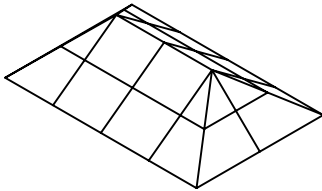

HIPPED RIDGE

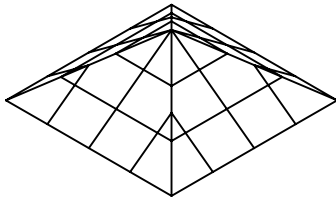

PYRAMID

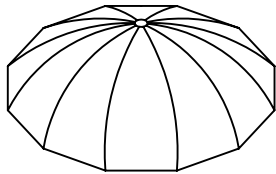

CURVED DOME

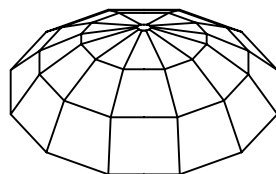

SEGMENTED DOME

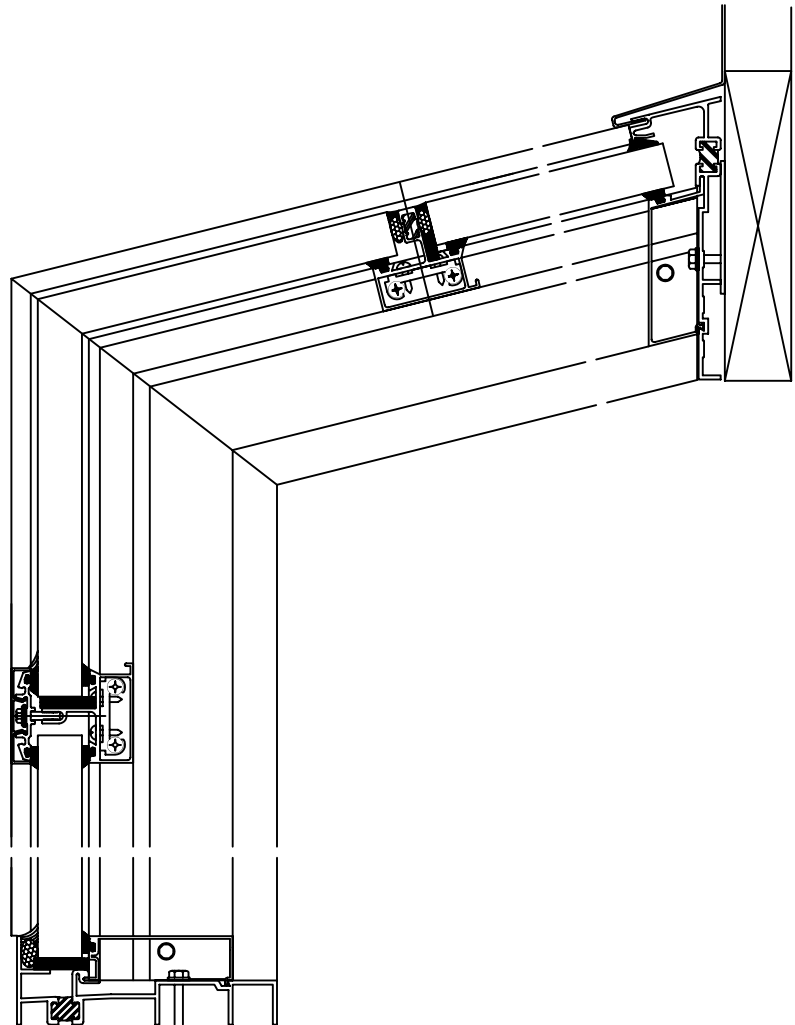
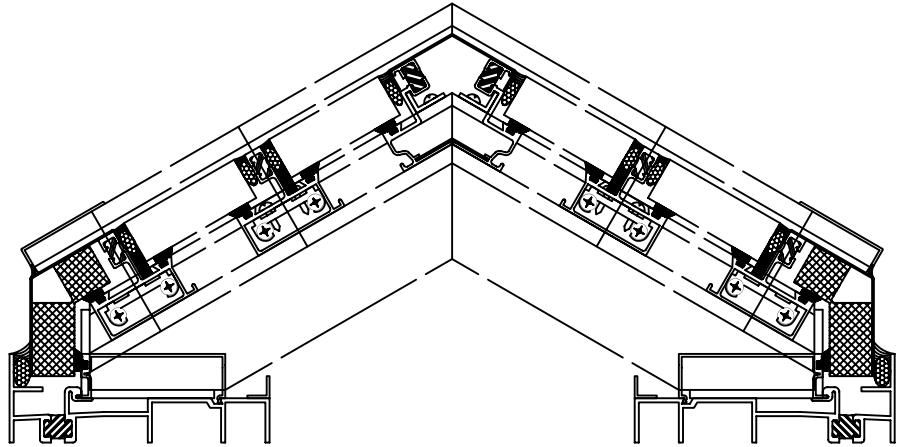

SCALE = HALF SIZE

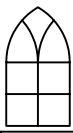

# J. Sussman, Inc.

## SK5000 Series

Architectural Skylights

Since 1906

America's finest custom windows

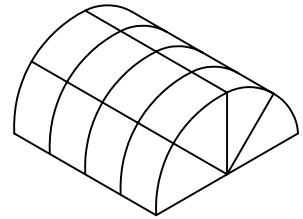
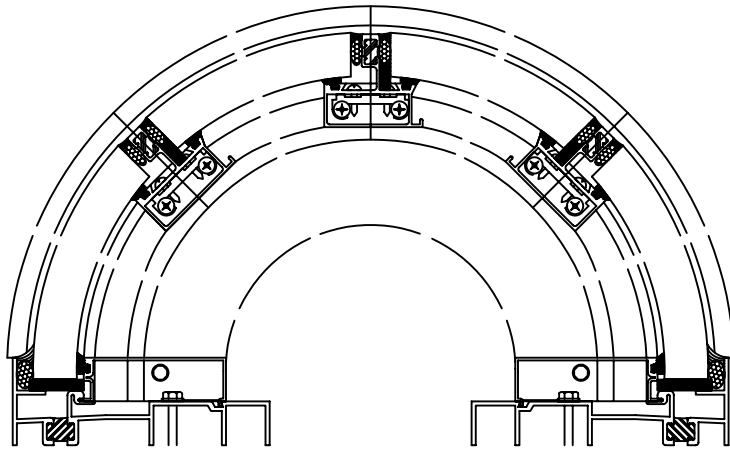

CURVED VAULT

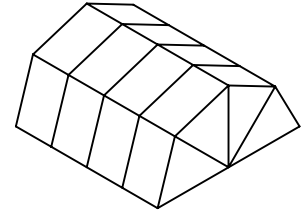

SEGMENTED VAULT

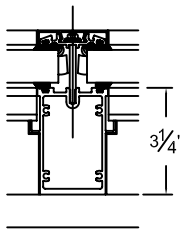

RAFTER

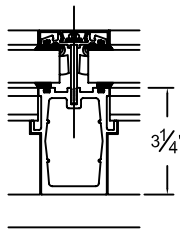

RAFTER

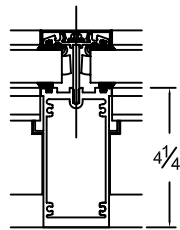

RAFTER

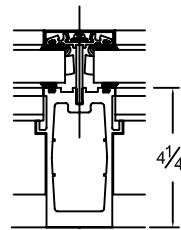

RAFTER

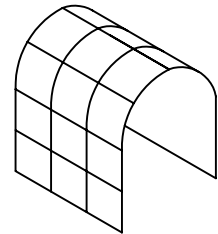

CURVED WALKWAY

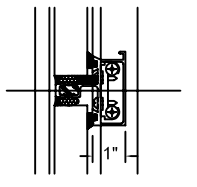

BUTT CROSS BAR

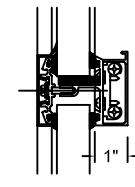

STD. CROSS BAR

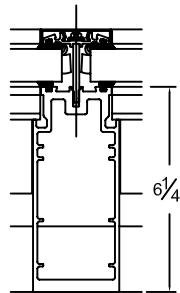

RAFTER

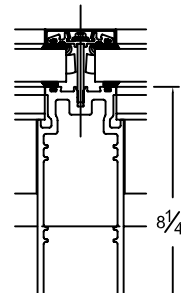

RAFTER

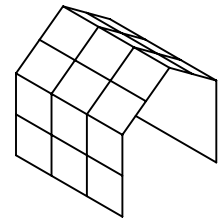

RIDGE WALKWAY

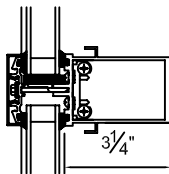

CROSS BAR

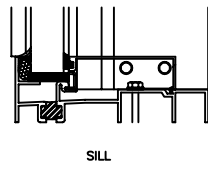

SILL

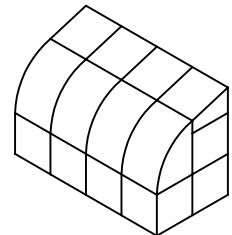

CURVED EAVE SUNROOM

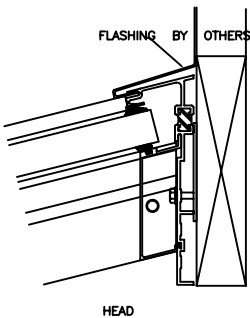

HEAD

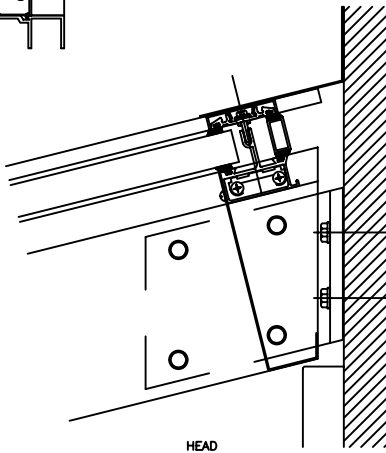

HEAD

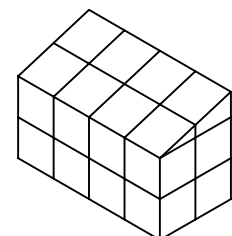

STRAIGHT EAVE SUNROOM

SCALE = HALF SIZE