

The 4200 series is a lighter weight thermally broken window utilizing Thermal Strip technology[©]. This series has been designed with metal strategically placed so that it is heavy enough to meet or exceed all HC performance specifications, yet light enough to make a significant difference in cost.

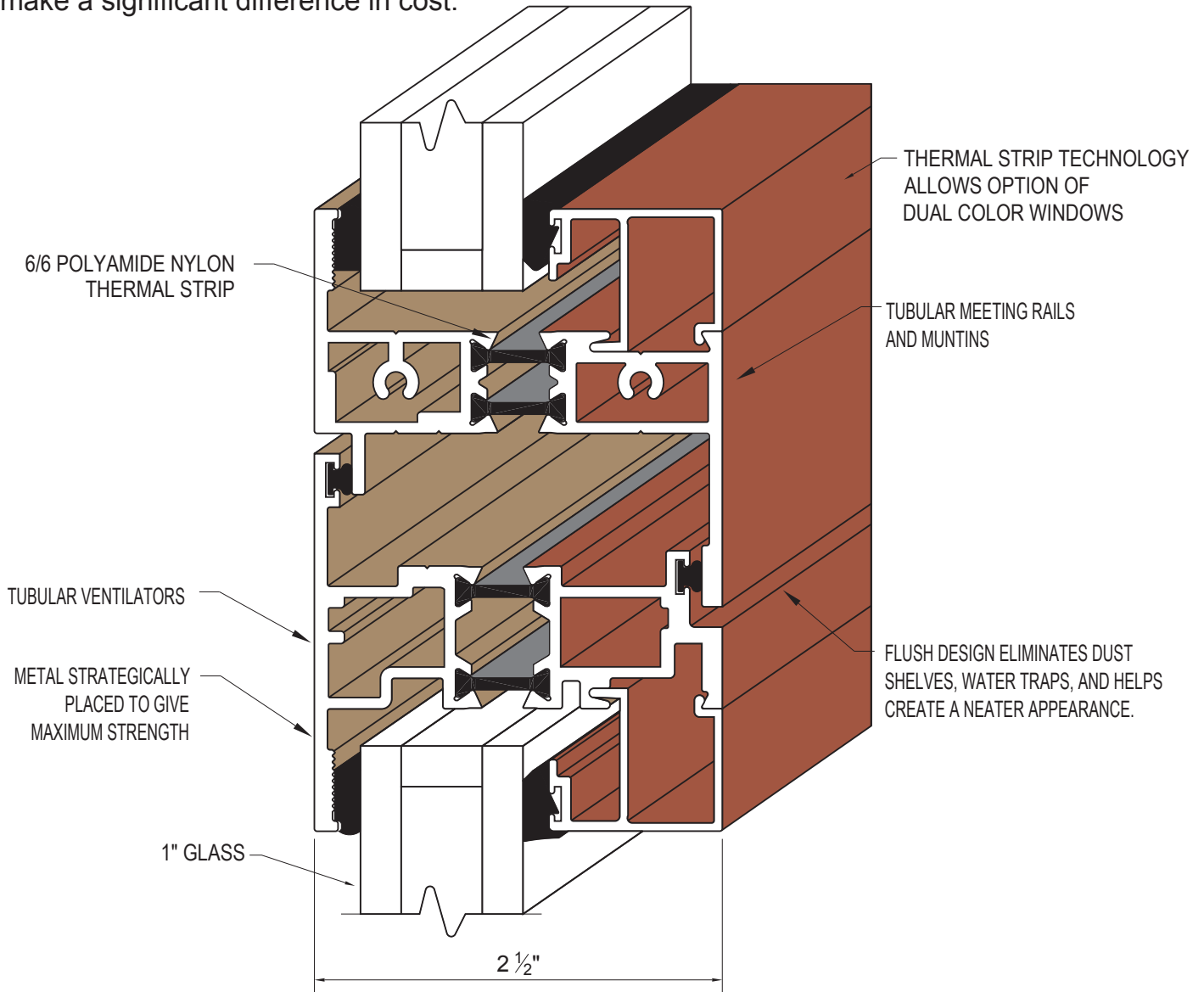

SCALE = FULL SIZE

Features:

- Full 2 1/2" deep frame with double tubular sash, muntins and intermediate rails. *(Consult factory for full specifications)*
- Thermal Strip technology for added strength and Dual Color finishing capability. **(Interior/Exterior)**
- All corners are fastened on each side of the thermal break. Sash corners are mitered, heavy angle reinforced and hydraulically crimped and epoxy welded.
- Flush design eliminates dust shelves and water traps and helps create a clean, neat appearance.
- Each ventilator has two wear resistant nylon glides independent of the hinge to insure maximum alignment and weather tightness.

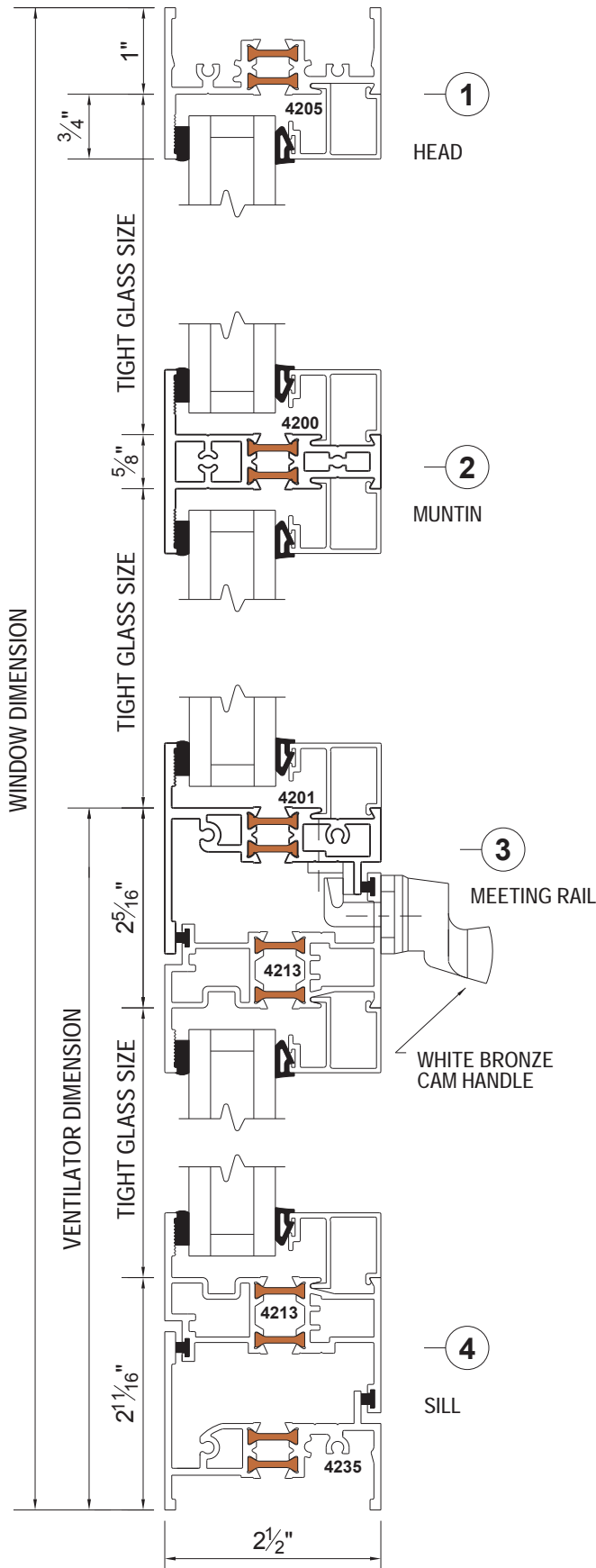
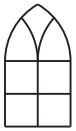

FIXED OVER PROJECT-IN

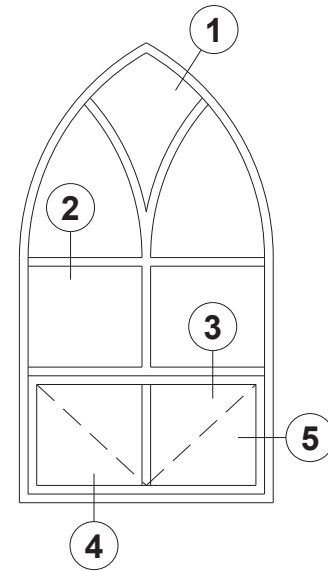

Typical Elevation

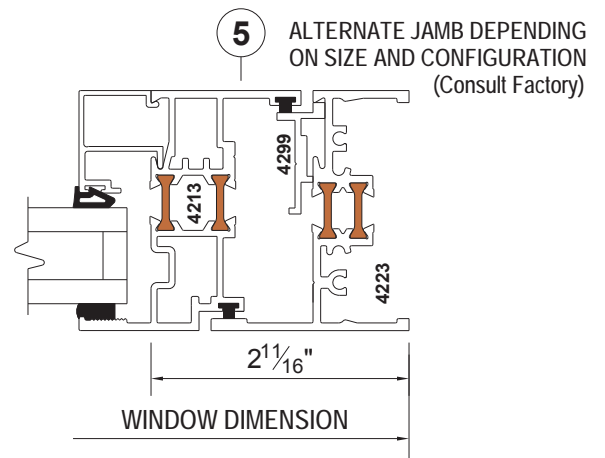
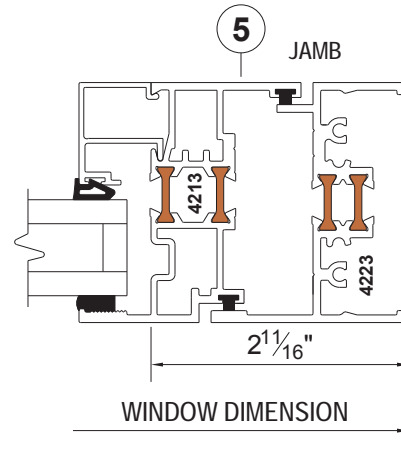

SCALE = HALF SIZE

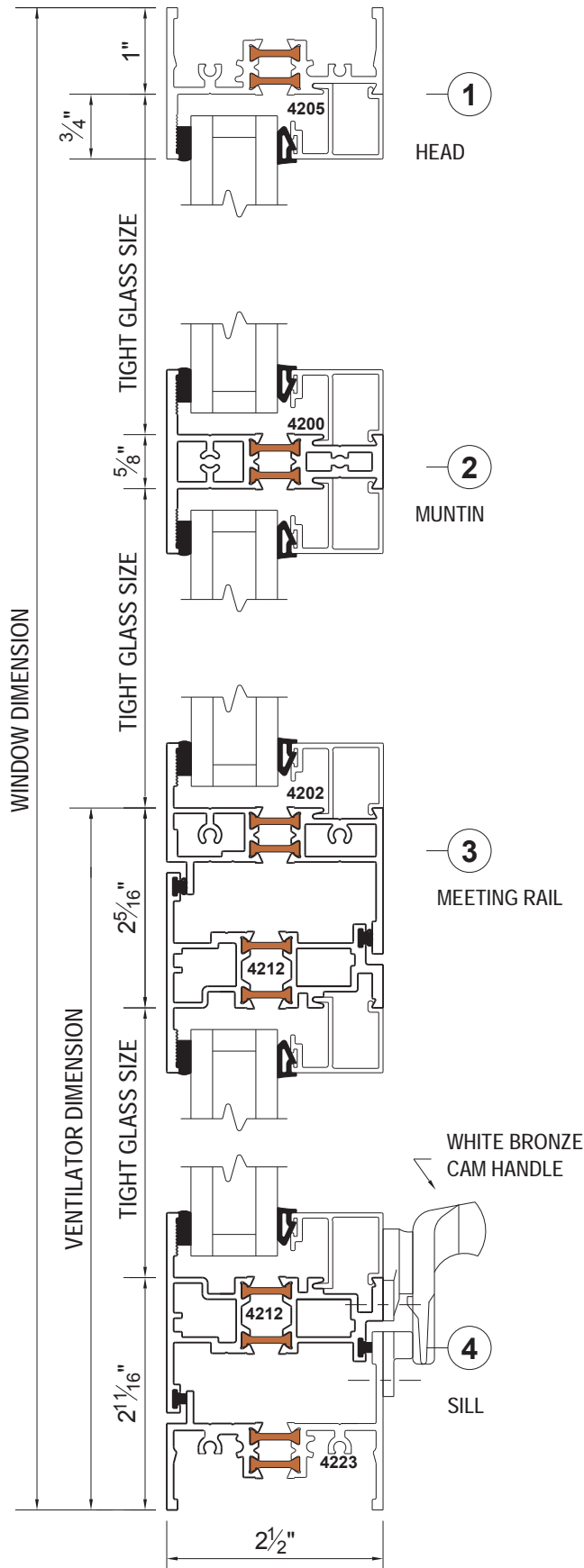

FIXED OVER PROJECT-OUT

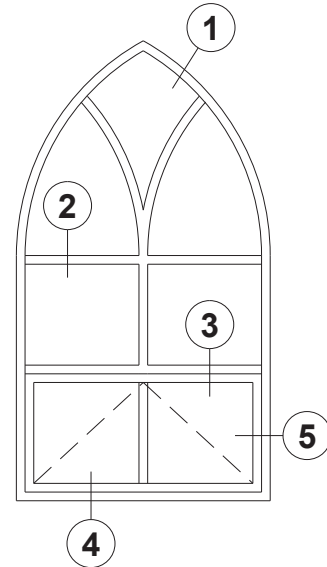

Typical Elevation

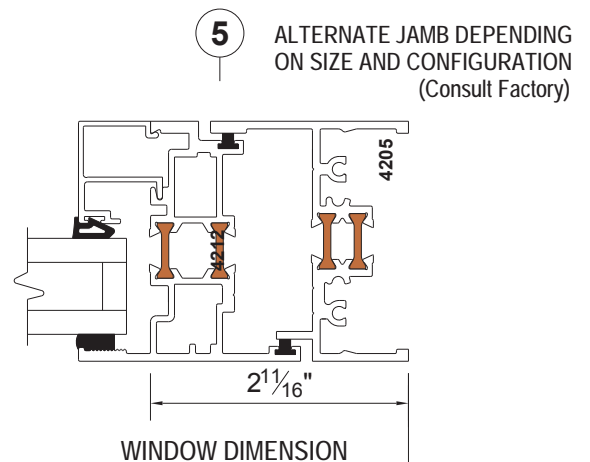
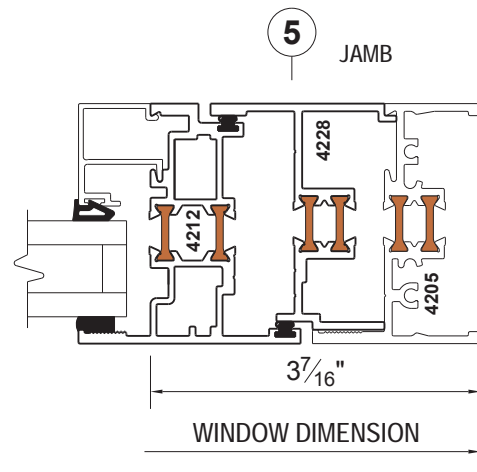

SCALE = HALF SIZE

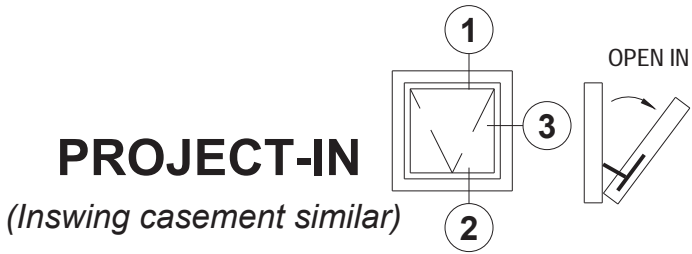
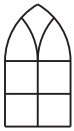

Standard Ventilator (equal leg frame)

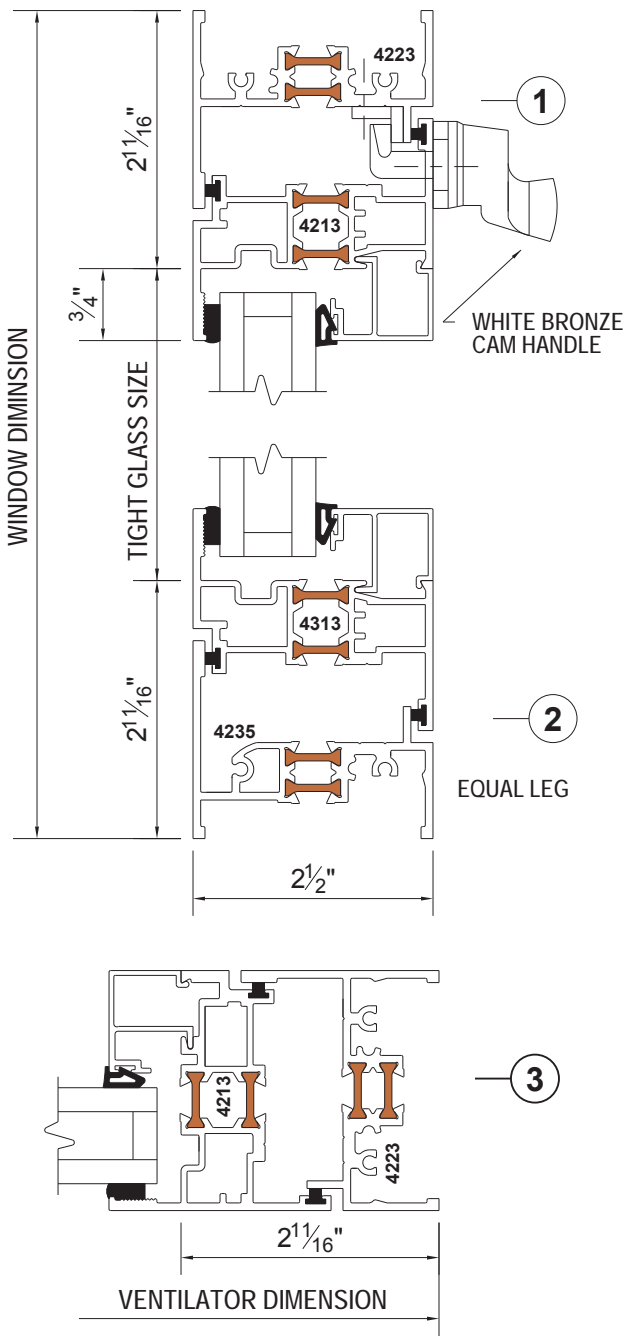

Alternate project-in ventilator sections that can be used at head, sill or jamb.

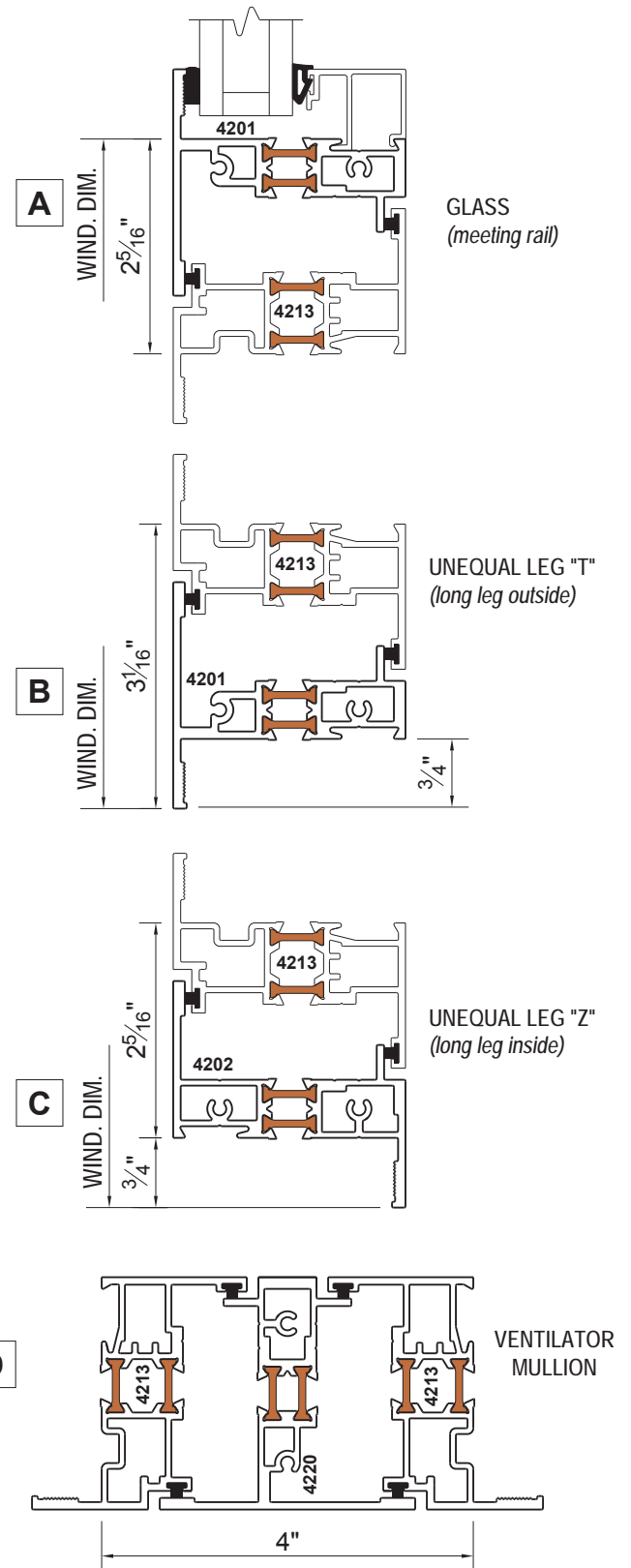

SCALE = HALF SIZE

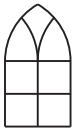

PROJECT-OUT

(Outswing casement similar)

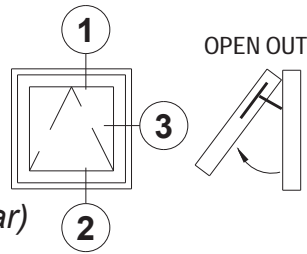

Standard Ventilator (equal leg frame)

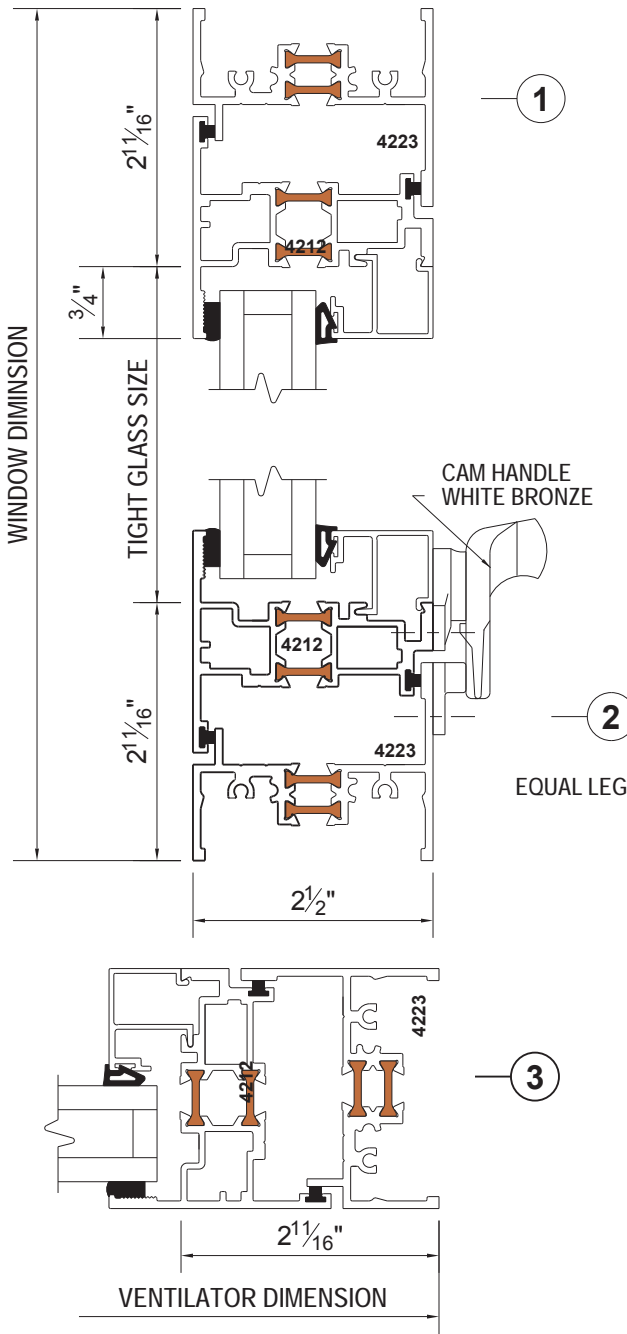

Alternate project-out ventilator sections that can be used at head, sill or jamb.

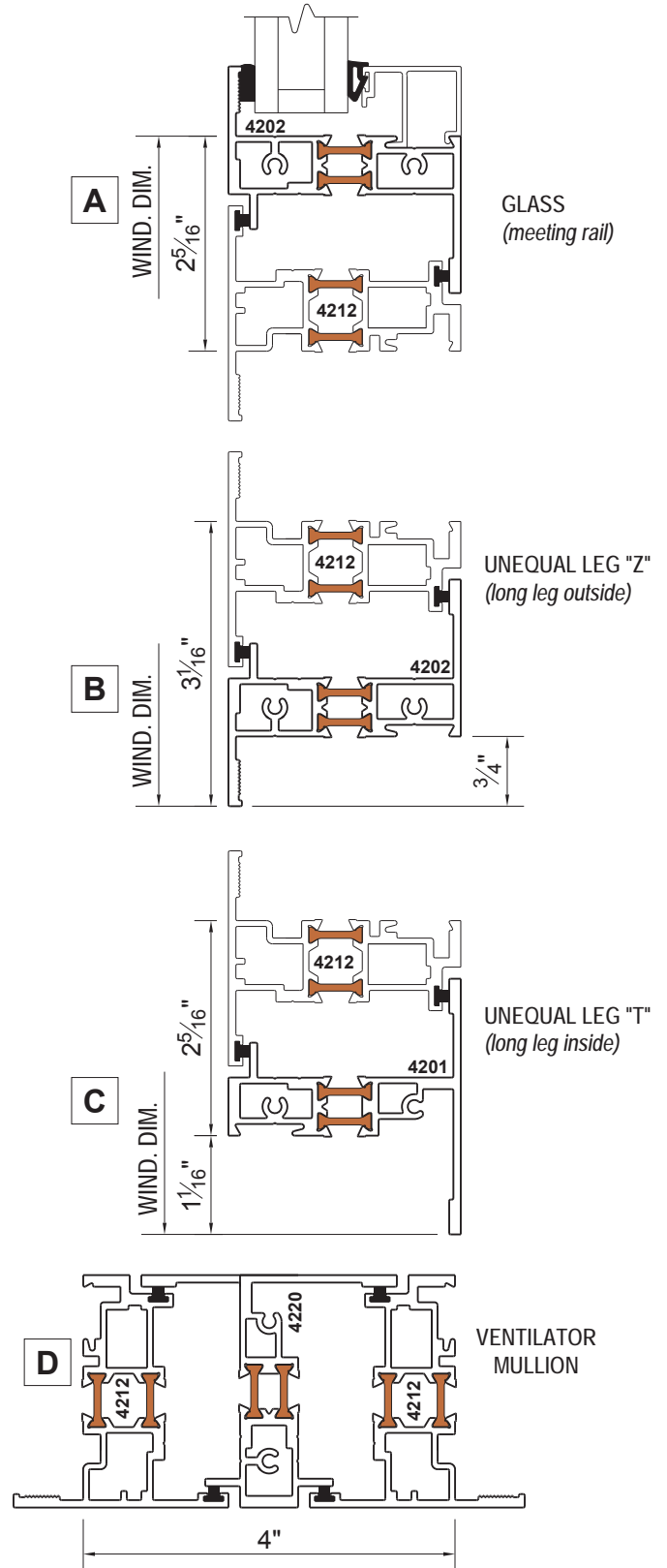

SCALE = HALF SIZE

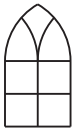

OUTSWING CASEMENT

Hardware not shown. Push-pull operation with cam handles and stainless steel concealed 4 bar hinges are standard. Crank operation with rotos and 5 knuckle extruded aluminum butt hinges are optional.

(equal leg frame)

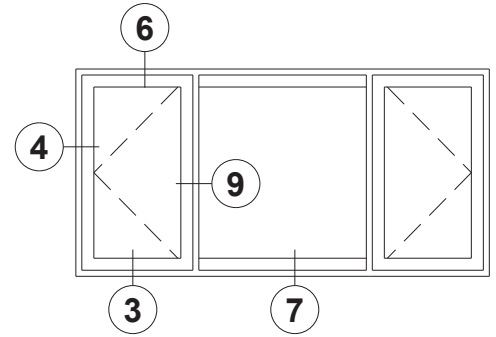
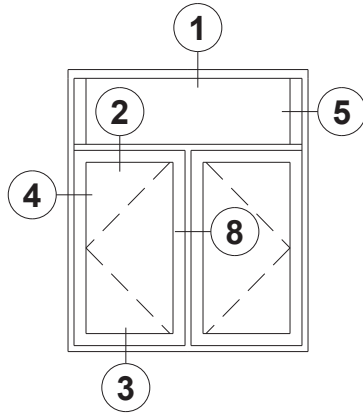
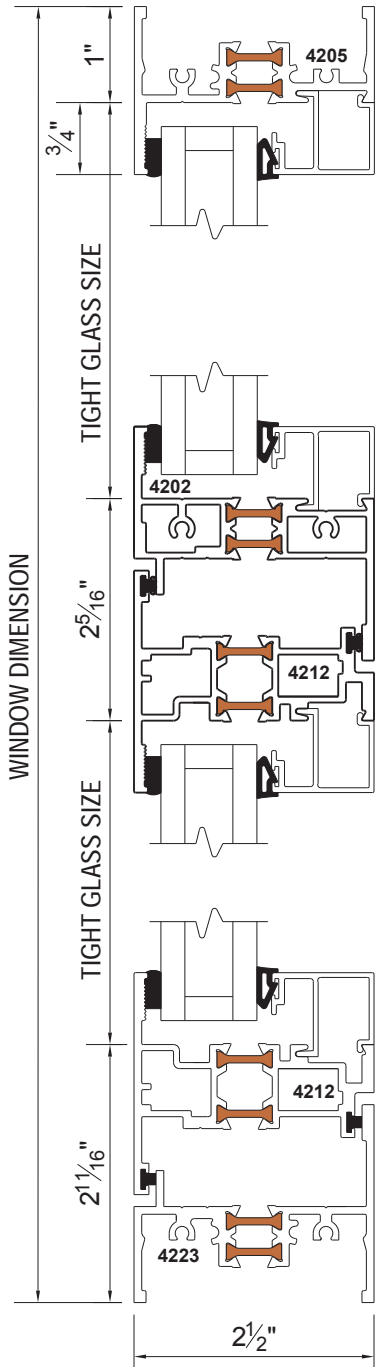

Typical Elevations

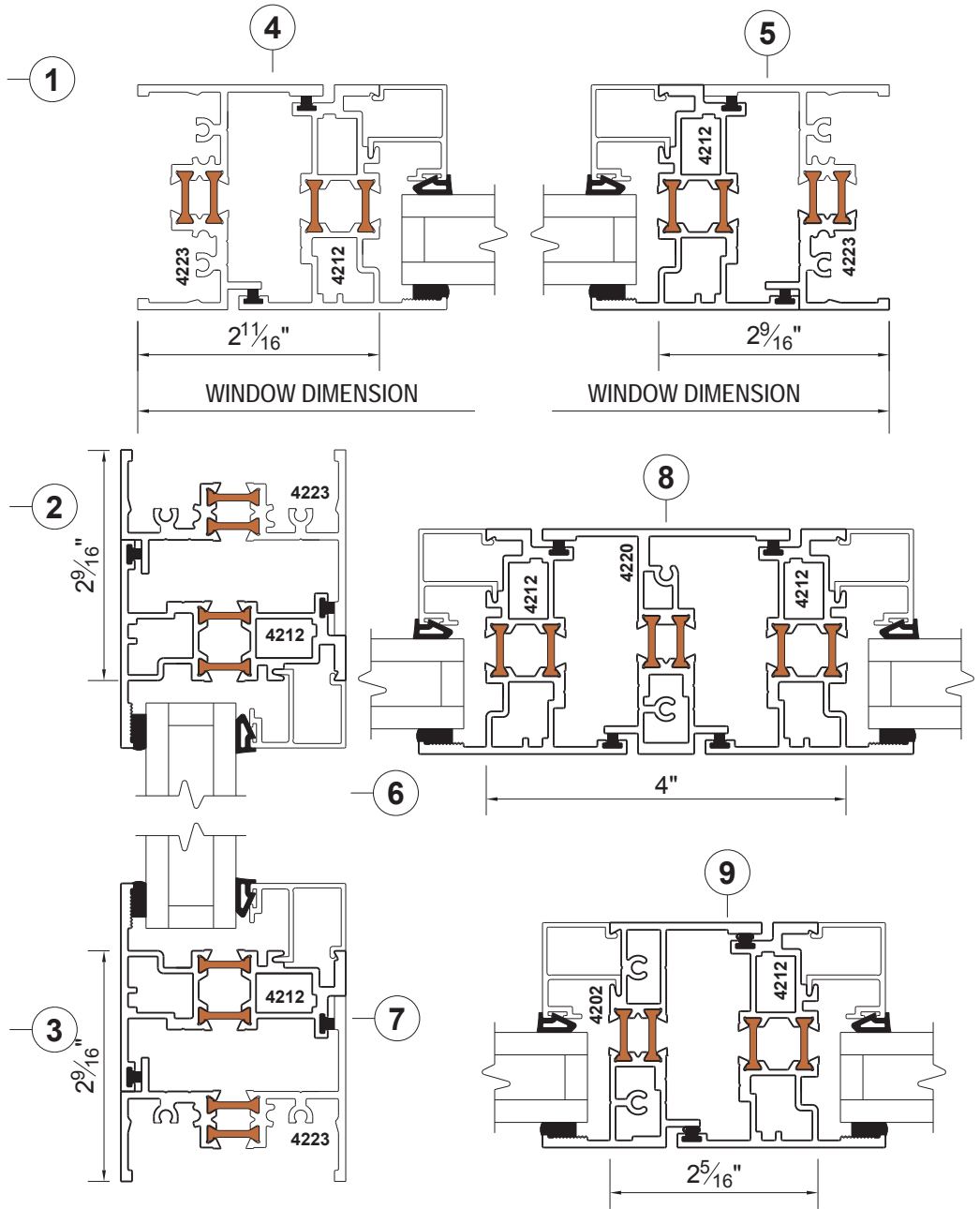

SCALE = HALF SIZE

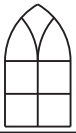

INSWING CASEMENT

Hardware not shown. Push-pull operation with cam handles and stainless steel 4 bar hinges are standard. 5 knuckle extruded aluminum butt hinges are optional.

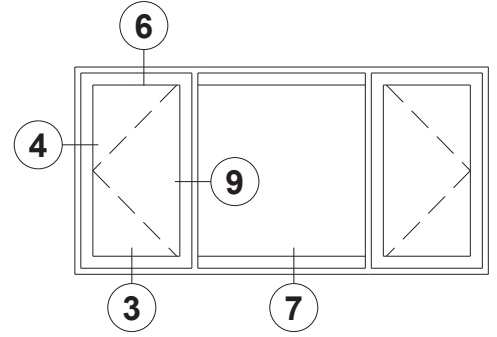
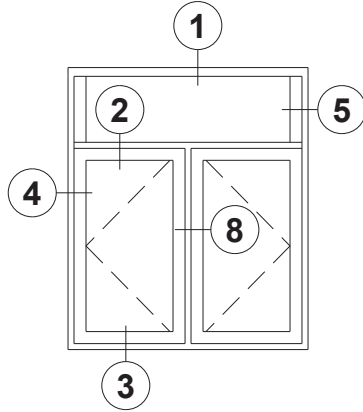

Typical Elevations

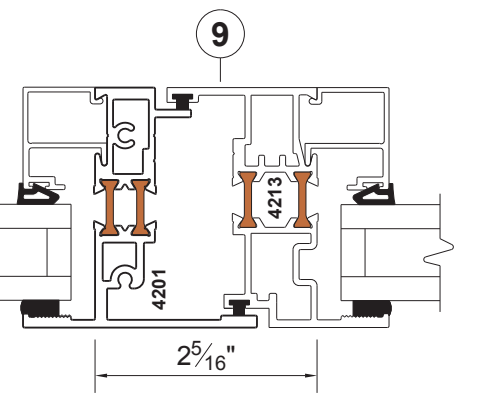
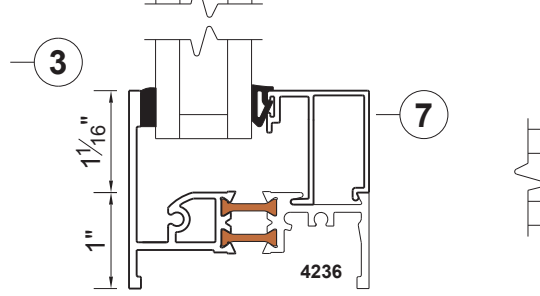
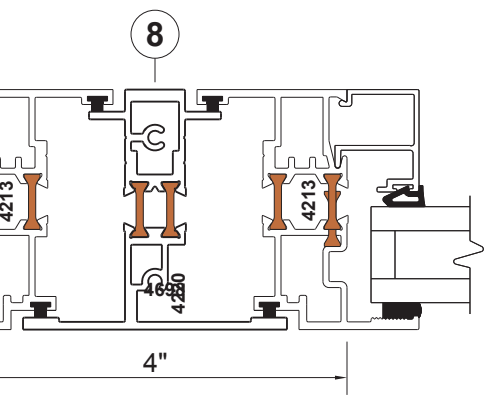
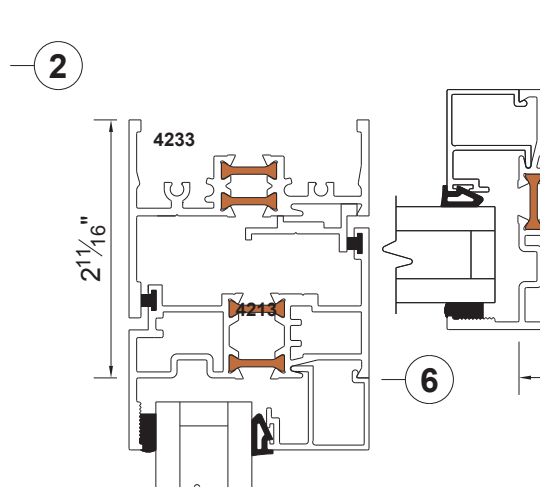
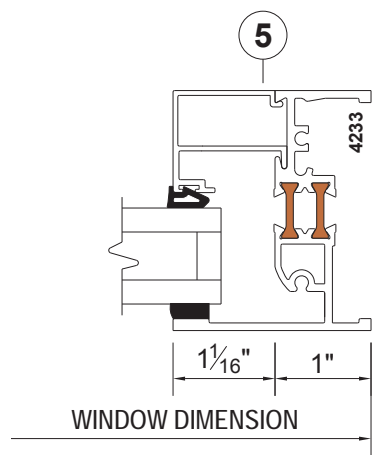
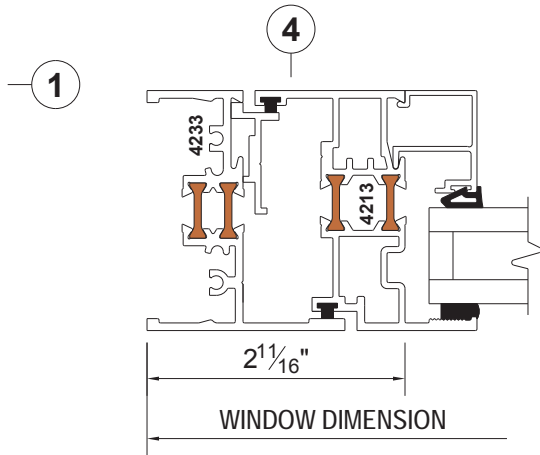
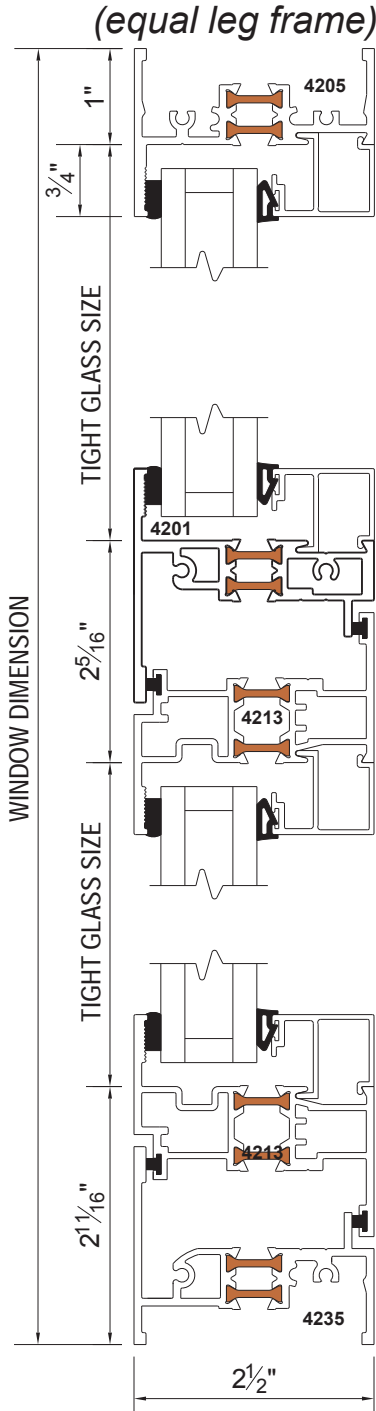

SCALE = HALF SIZE



4200 SERIES GUIDE SPECIFICATIONS
Fixed, Projected and Casement
SECTION 08 51 13 (08520) ALUMINUM WINDOWS

(Text in parentheses and italics are notes to spec writer and are not to be included in specification.)

Part 1 GENERAL

1.01 Work Included

- A. Furnish and install aluminum architectural windows complete with all necessary hardware and related components as shown on drawings and specified in this section.
- B. Glass and Glazing
 - 1. Provide in accordance with Section 08 81 00 – Glass and Glazing (08800).

1.02 Related Work

- A. Section 07 92 00 – Joint Sealants (09715)
- B. Section 08 32 00 – Sliding Glass Doors (08314)
- C. Section 08 41 00 – Entrances and Storefronts (08400)
- D. Section 08 42 33 – Balanced Entrance Doors (08480)
- E. Section 08 51 66 – Metal Window Screens (08586)
- F. Section 08 44 00 – Curtain Walls and Glazed Assemblies (08900)
- G. Section 08 44 33 – Sloped Glazing Assemblies (08960)

1.03 References (See AAMA GS-001 and AAMA 101 For Current Applicable Listings)

- A. AAMA (American Architectural Manufacturers Association):
- B. ANSI (American National Standards Institute):
- C. ASTM (American Society for Testing and Materials):
- D. CPSC (Consumer Product Safety Commission):
- E. FGMA (Flat Glass Marketing Association):
- F. GSA (General Services Administration):

1.04 Items Installed But Not Furnished

(Enter description, e.g., louver supplied by others to be installed in new window)

1.05 Items Furnished But Not Installed

(Enter description, e.g., extra sash sets to be supplied and stored for the future)

1.06 Testing and Performance Requirements

- A. Windows shall conform to the requirements of AAMA/WDMA/CSA 101/I.S.2/A440-05 performance grade FW-AW55, AP-HC65. In addition, the following specific performance requirements must be met.
- B. Laboratory Test Procedure and Performance Requirements
 - 1. Air Infiltration: When tested in accordance with ASTM E 283, air infiltration shall not exceed 0.01 cfm/ft fixed, .04 cfm/ft projected under a static pressure drop of 6.24 psf.
 - 2. Water resistance: When tested in accordance with ASTM E 331 and ASTM E 547 there shall be no water leakage when the window is subjected to a pressure drop of 12 psf fixed, 12 psf projected.
 - 3. Uniform Structural Load Test: When tested in accordance with ASTM E 330 with a static pressure difference of 82.5 psf fixed 105 psf projected positive and negative there shall be no glass breakage, permanent damage to fasteners, hardware parts or actuating mechanisms which would cause the window to be inoperable. Permanent deformation of any frame or vent member shall not exceed .2% of its span
 - 4. Forced Entry: When tested in accordance with ASTM F 588 or AAMA 1302.5 windows shall meet the requirements of performance level 10.
 - 5. Condensation Resistance Factor (CRF): When tested in accordance with AAMA 1503.-98, the condensation resistance factor (CRF) shall be no less than 59.



6. Thermal Transmittance (U Value): When tested in accordance with AAMA 1503.-98, the thermal transmittance due to conduction (Uc) shall not exceed .40 BTU/hr/sf/°F

1.07 Quality Assurance

- A. Test reports from an independent certified laboratory shall be available upon request.
- B. *Field Quality Control (Optional)*
 1. Testing Agency: Engage a qualified testing agency to perform tests and inspections and prepare test reports.
 - a. Testing and inspecting agency will interpret tests and state in each report whether tested work complies with or deviates from requirements.
 2. Testing Services: Testing and inspecting of installed windows shall take place as follows:
 - a. Testing Methodology: Testing Standard shall be per AAMA 502 including reference to ASTM E 783 for Air Infiltration Test and ASTM E 1105 for Water Penetration Test.
 1. Air Infiltration Test: Conduct test in accordance with ASTM E 783 at a minimum uniform static test pressure of 1.57 psf (75 Pa) for CW or 6.24 psf (300 Pa) for AW. The maximum allowable rates of air leakage for field testing shall not exceed 1.5 times the project specifications.
 2. Water Infiltration Test: Water penetration resistance tests shall be conducted in accordance with ASTM E 1105 at a static test pressure equal to 2/3 the specified water test pressure.
 - b. Testing Extent: Architect shall select window units to be tested as soon as a representative portion of the project has been installed, glazed, perimeter caulked and cured. Conduct tests for air infiltration and water penetration with manufacturer's representative present.
 - c. Test Reports: Shall be prepared according to AAMA 502.

1.08 Submittals

- A. The window manufacturer shall submit shop drawings, finish samples, test reports, warranties and maintenance manuals per the requirements of architect.

1.09 Delivery, Storage and Handling

- A. Store and handle windows and other components in strict compliance with manufacturer's instructions.
- B. Protect units against damage from the elements, construction activities and other hazards before, during, and after installation.

1.10 Warranties

- A. Submit written warranties from window manufacturer for the following:
 1. Windows: Windows furnished are certified as fully warranted against any defects in material or workmanship under normal use and service for a period of one (2) years from date of fabrication.
 2. Finish: The pigmented organic finishes on windows and component parts (such as panning, trim, mullions, and the like) are certified as complying fully with the requirements of the AAMA 260X specification and fully warranted against chipping, peeling, cracking or blistering for a period of five (5) years from date of installation.

Part 2 PRODUCTS

2.01 Manufacturers

- A. All windows shall be Series No. 4200 2 1/2" deep thermally broken custom window as manufactured by J. Sussman, Inc. of 109-10 180 St., Jamaica NY 11433.
- B. Other manufacturers desiring approval shall:
 1. Furnish a sample window and valid test reports indicating full compliance with all performance requirements of this specification at least 10 days prior to bid date.
 2. Have been engaged in the fabrication of aluminum windows for ten years and this type of window for 5 years and shall submit for review a list of similar completed projects.
 3. Approval of "equal" products shall be in the form of a written addendum. Substitute products not pre-approved by the Architect via addenda will not be considered.
 4. Base bid will be J. Sussman, Inc.

2.02 Materials

- A. Extruded aluminum shall be 6063-T5 alloy and temper with a minimum ultimate tensile strength of 22,000 psi. Comply with ASTM B 221



- B. Thermal barriers shall consist of two fiberglass reinforced 6/6 polyamide nylon strips mechanically crimped in knurled raceways in the exterior and interior extrusions. Poured and debridged urethane thermal barriers will not be permitted.
- C. Fasteners shall be aluminum, stainless steel or other materials warranted by the manufacturer to be non-corrosive and compatible with aluminum window members, trim, hardware, anchors and other components of the window units.

2.03 Fabrication

A. General

1. All main sections shall have a minimum depth of 2 1/2" with a nominal wall thickness of .125 to .080.
2. Glazing rebates shall not be less than 3/4" in height.
3. Window members must incorporate the glazing legs as an integral part of the frame, sash, and muntin bar design. Mechanically applied glazing legs will not be accepted.
4. All main sections shall utilize a thermal barrier to separate the exterior and interior metal surfaces
5. Thermal barriers shall be positioned at the center of every section and align at all frame and sash corners.
6. No hardware or fasteners of any kind shall bridge or penetrate the thermal barrier.
7. All muntins, meeting rails and ventilator sash shall be double tubular.
8. All joints shall be cut to a hairline fit and be either fully sigma arc welded, heavy angle reinforced, cold welded and hydraulically crimped, double fastened with stainless steel screws or any combination thereto.
9. All joints shall be factory sealed.

B. Ventilators

1. Ventilators shall be project-in, project-out, in-swing casement, out-swing casement or combinations thereof as shown on the plans.
2. All sash extrusions shall be double tubular.
3. Each corner shall be mitered, heavy angle reinforced, cold welded epoxy adhesive and hydraulically crimped.
4. Ventilators and frames must be on the same plane and present a flush interior and exterior surface. Overlap or extensions of ventilators beyond the frame will not be acceptable.
5. Projected ventilators shall operate in two specially designed wear resistant weatherproof nylon glides independent of the hinge to insure both maximum alignment and weather tightness in the closed position.
6. The void between the ventilator sash and frame shall be pressure equalized to outside conditions.

C. Glazing Beads

1. Glazing beads shall be extruded from 6063-T5 alloy and be not less than .050 thick.
2. The glazing beads will be snap in type to securely interlock into the extruded window members without extending underneath the glass.
3. They shall be factory fitted and attached.
4. Glazing beads shall also be secured with stainless steel fasteners where required.

D. Weatherstripping

1. Each sash shall have 2 continuous rows of tested Schlegel Q-Lon weatherstripping installed in specially designed dovetail grooves.
2. Weatherstripping shall have a rigid backing that will resist pullout. A single durometer vinyl or rubber weatherstripping will not be accepted.

E. Screens (*Optional*)

1. Insect screens shall be constructed of extruded aluminum tubular frames. Roll formed screen frames will not be accepted.
2. Screens for project in ventilators and in-swing casements shall be removable from the interior.
3. Screens for project-out ventilators and push/pull operated out-swing casements shall be of the hinged wicket type. Screen frames shall be finished to match the windows.
4. Screen cloth shall be 18x16 fiberglass mesh. (*Aluminum mesh optional.*)
5. Screen spline shall be extruded vinyl, removable to permit re-screening.
6. Screen mounting holes in the windows frame shall be factory drilled.



2.04 Hardware

- A. Hardware shall conform to the requirements of the ventilator and shall be factory fitted and attached with stainless steel screws.
- B. Locking handles for projecting ventilators shall be cam type and be solid white bronze with a US25D satin polished finish. *(Custodial locks and pole-operated handles are optional.)*
- C. Projected ventilators shall operate on stainless steel four bar heavy duty concealed friction hinges conforming to AAMA 904.1.
- D. Out-Swing Casements shall operate on *(choose one)*
 - 1. *(Standard)* stainless steel four bar heavy duty concealed friction hinges conforming to AAMA 904.1.
 - 2. *(Optional)* 5 knuckle extruded aluminum butt hinges with 1/4" diameter stainless steel pins and nylon bushings and *(choose one)*
 - a. *(Option 1)* Zinc die cast roto operators compatible with aluminum and shall meet ASTM E405.
 - b. *(Option 2)* heavy duty stainless steel friction adjusters.
 - c. *(Option 3)* stainless steel limit opening devices with release key.
- E. In-Swing Casements shall operate on *(choose one)*
 - 1. *(Standard)* stainless steel four bar heavy duty concealed friction hinges conforming to AAMA 904.1.
 - 2. *(Optional)* 5 knuckle extruded aluminum butt hinges with 1/4" diameter stainless steel pins and nylon bushings *(the following are optional with butt hinges)*
 - a. *(Option 1)* and heavy duty stainless steel friction adjusters.
 - b. *(Option 2)* and stainless steel limit opening devices with release key.

2.05 Finish

- A. The finish of the aluminum windows shall be *(Architect to select. Note: this series is available with different finishes on the interior and exterior. If "two tone" finishing is desired, specified each side separately.) (Standard finishes are considerably less expensive and lead times for windows are much shorter with standard finishes.)*
 - 1. Architectural Class II Anodic (204-R1) AA M12-C22-A31 Thickness to be .4 mil and shall conform to AAMA 611-98.
 - a. Color: Clear Anodized *(Standard)*
 - 2. Architectural Class I Anodic (215-R1) AA M12-C22-A41 Thickness to be .7 mil and shall conform to AAMA 611-98.
 - a. Color: Clear Anodized *(Optional - Consult factory)*
 - 3. Architectural Class I Anodic with electrostatically deposited color AA-M12-C22-A44. Thickness to be .7 mil and shall conform to AAMA 611-98.
 - a. Color: Dark Bronze Anodized *(Standard)*
 - b. Color: Black Anodized *(Standard)*
 - c. Color: _____ *(Insert anodized color selected by Architect. Consult factory)*
 - 4. Baked acrylic enamel organic finish electrostatically applied over pretreated aluminum. Finish shall be a one coat, one bake paint system with a .8 mil minimum overall dry film thickness and shall conform to AAMA 2603.
 - a. Color: Bronze Paint *(Standard)*
 - b. Color: White Paint *(Standard)*
 - c. Color: _____ *(Insert custom paint color selected by Architect. Consult factory)*
 - 5. High performance organic finish electrostatically applied over pretreated aluminum. Finish shall be based on 50% fluoropolymer resin and be applied as a two coat, two bake paint system with a 1.2 mil minimum thickness and shall conform to AAMA 2604. *(Some colors may require a clear protective topcoat to protect the pigmented coating.)*
 - a. Color: _____ *(Insert custom paint color selected by Architect. Consult factory)*
 - 6. High performance organic finish electrostatically applied over pretreated aluminum. Finish shall be based on 70% fluoropolymer resin and be applied as a two coat, two bake paint system with a



1.2 mil minimum thickness and shall conform to AAMA 2605. *(Some colors may require a clear protective topcoat to protect the pigmented coating.*

- a. Color: _____ *(Insert custom paint color selected by Architect. Consult factory)*

PART 3 EXECUTION

3.01 Inspection

- A. Verify that openings are dimensionally correct and within allowable tolerances.
- B. Openings must be plumb, level, and clean.
- C. Provide a solid anchoring surface that is in accordance with approved shop drawings.

3.02 Installation

- A. Use only skilled craftsmen for work to be done in accordance with the manufacturer's installation instructions and/or approved shop drawings and specifications.
- B. Windows and materials must be set square and level.
- C. Adequately anchor to maintain positions permanently when subjected to normal thermal movement, specified building movement, and specified wind loads.
- D. Adjust Windows for proper operation after installation has been completed.
- E. Furnish and apply sealants to provide a weather tight installation at all joints and intersections and at opening perimeters. Wipe off excess material and leave all exposed surfaces and joints clean and smooth.

3.03 Protection and Cleaning

- A. After completion of window installation, all windows shall be inspected, adjusted, and left in working order.
- B. Windows shall be cleaned to remove mortar, plaster, paint or other contaminants.
- C. After cleaning, all work shall be protected against damage until it is accepted by the General Contractor.
- D. Thereafter, it shall be the responsibility of the General Contractor to maintain protection and provide final cleaning.
- E. Send to Architect, with copy to Owner, written recommendations for maintenance and protection of windows following Substantial Completion of Window Contract.

END OF SECTION

The above specifications are subject to change without notice.